

Tri-Boro Shelving Features

Tri-Boro Shelving is manufactured in the widest range of sizes available in the industry. When used in combination this array of sizes can meet the most demanding of custom applications.

The flanged shelf is manufactured from cold rolled steel and has "Triple Bends" on all four sides for incomparable strength.

Standard shelves are manufactured in 24", 30", 36", 42" and 48" widths, and 9", 12", 15", 18", 24", 30" and 36" depths.



All Tri-Boro steel components receive a rust resistant phosphatized cleaning for better paint adhesion and durability. A custom, quality blended powder coat paint is applied "Electro-Staticly" and then baked on in a continuous curing oven for lasting durability and outstanding appearance. This process is the latest innovation for the integrity of paint surface and the protection of our environment.

STANDARD FINISHES

Tri-Boro's standard finish is Gray. However, all colors shown are available for a small additional charge. The choice of an alternate color may create a slight delay in delivery.

SHELF TYPES

Flange Shelf



Class 0 – No Re-Bar

Class 1 – 1 Re-Bar

Class 2 – 2 Re-Bar

Flange Shelves are available in both 20 GA. and 18 GA. material thickness. Class 0 is designed for applications that do not require extreme load bearing strength.

The addition of 1 Re-Bar will increase bearing strength by about 50%. The addition of 2 Re-Bars will increase the bearing strength by over 100%. Please see the chart on page 7 for exact load bearing strengths.

Boxer Shelf

Boxer Shelves are constructed of 22, 20 or 18 gauge steel with full welded box formation in front and back of the shelf and have formed channels on both ends. All corners are lapped and welded for additional strength.

The box formation is welded on a 6" center minimum to provide integrity the entire length of the box. All shelves have a box profile height of 1-1/4". All boxer shelves accommodate either clip or nut and bolt connection to the upright.

Please see the chart on page 7 for exact load bearing strengths.



Tri-Boro's "Boxer"™ industrial grade steel shelving features a welded tubular box design with lapped and welded seam corners.

POST TYPES

Tri-Boro manufactures rigid roll formed "Box" and companion "Offset Angle" type posts.

The box post provides unobstructed shelf access. One box post takes the place of two angle posts at the front of a shelving unit.

The offset angle post reduces shelf accessibility by 1 inch per end, although the field length is nominal to the dimension ordered.

Box style post heights range from 3'1" to 11'3". Offset Angle heights range from 3'1" to 12'3".

Both styles are manufactured in 1 foot increments. All posts are 14 gauge steel. Shelves can be either clipped or nut & bolted to the post.



Box Post Holes 1-1/2" O.C.



Offset Angle Post Holes 1-1/2" O.C.



Rolled Formed Angle Post Holes 1" O.C.



Government Post Holes 1" O.C.



Offset Angle Post Holes 1" O.C.

Heavy Duty Box Style and Heavy Duty Offset Posts

Heights range from 7'3" to 28'. Both styles are manufactured in 1 foot increments. All posts are standard 13 gauge (Also available in 12 gauge). Shelves can be either clipped or nut and bolted to the post.



Heavy Duty Box Post

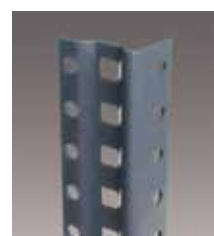

Heavy Duty Offset Post

Tri-Boro Shelf Load Capacities

FLANGE SHELF



- TRIPLE BENDS ALL FOUR SIDES
- 8 DEPTHS
- 5 WIDTHS
- 20 GA. AND 18 GA.

BOXER™ (BOX SHELF)



- FULL WELDED BOX FORMATION (FRONT AND BACK)
- 6 DEPTHS
- 5 WIDTHS
- 22 GA., 20 GA. AND 18 GA.

FLANGE SHELVES LOAD CAPACITY COMPARISON CHART

Size	20 GA.	18 GA.	1 Rebar 20 GA.	1 Rebar 18 GA.	2 Rebar 20 GA.	2 Rebar 18 GA.
12" x 36"	300	725	475	900	650	1075
12" x 42"	250	500	425	675	600	850
12" x 48"	225	400	400	575	575	750
15" x 36"	300	700	475	875	650	1050
15" x 42"	225	475	400	650	575	825
15" x 48"	200	400	375	575	550	750
18" x 36"	300	700	475	875	650	1050
18" x 42"	255	450	430	625	605	800
18" x 48"	175	375	350	550	525	725
24" x 36"	300	650	475	825	650	1000
24" x 42"	200	450	375	625	550	800
24" x 48"	175	325	350	500	525	675
30" x 36"	200	500	375	675	550	850
30" x 42"	175	400	350	575	525	750
30" x 48"	125	300	300	475	475	650
36" x 36"	175	400	350	575	525	750
36" x 42"	175	400	350	575	525	750
36" x 48"	125	300	300	475	475	650

BOXER™ SHELVES LOAD CAPACITY COMPARISON CHART

Size	22 GA. Capacity	20 GA. Capacity	18 GA. Capacity
12" x 36"	600	850	1100
12" x 42"	450	650	900
12" x 48"	400	550	750
15" x 36"	600	825	1100
15" x 42"	450	625	900
15" x 48"	400	600	850
18" x 36"	600	850	1200
18" x 42"	500	650	950
18" x 48"	400	550	900
24" x 36"	550	850	1200
24" x 42"	450	650	1000
24" x 48"	375	550	900
30" x 36"	-	650	1200
30" x 42"	-	625	900
30" x 48"	-	500	750
36" x 36"	-	550	900
36" x 42"	-	525	850
36" x 48"	-	500	750

Tri-Boro Hinged Doors for Shelving

- HINGED DOORS CONSTRUCTED OF DURABLE 20 GAUGE STEEL, 13 GAUGE FRAME
- DOORS EQUIPPED WITH THREE-POINT LOCKING DEVICE, OPEN 180 DEGREES
- 85" H & 73" H DOORS HAVE A PAN REINFORCEMENT, SPOT WELDED ON EACH SIDE
- TOP AND BOTTOM LOCKING ROD CHANNELS
- EASY TO INSTALL! DOORS PRE-ASSEMBLED AND READY TO INSTALL
- INCLUDED: STANDARD SATIN CHROME FINISHED HANDLE WITH LOCK & 2 KEYS (Keyed Differently)
- DOORS WILL FIT OFFSET & ROLLED-FORMED POSTS

(Doors Only - Shelving components sold separately. Not for use with box posts.)

Catalog No.	W x H	Wt. (lbs.)
HD3637	36" x 37"	35.0
HD3673	36" x 73"	65.0
HD3685	36" x 85"	70.0
HD4837	48" x 37"	40.0
HD4873	48" x 73"	85.0
HD4885	48" x 85"	90.0
HDK2	Extra Key	



37" H



73" H



85" H

Standard Doors Available in 3 Heights: 37", 73" & 85"

Tri-Boro Shelving Posts & Standard Foot Plates



OFFSET ANGLE POST 1-1/2" O.C.

Made of 14 gauge cold-rolled steel, roll formed into a 1" x 1-7/8" angle. The wide flange is punched on 1-1/2" centers with 7/16" square slots to receive shelf clips and 5/16" diameter holes on 1-1/2" centers for the attachment of side sway braces or solid panels.

Model Number	Size	Wt.
OP37	3'1"	2.0
OP49	4'1"	3.0
OP61	5'1"	4.0
OP73	6'1"	4.8
OP85	7'1"	5.5
OP97	8'1"	6.0
OP109	9'1"	7.0
OP121	10'1"	8.0
OP133	11'1"	8.8
OP145	12'1"	9.5



OFFSET ANGLE POSTS 1" O.C.

Made of 14 gauge cold-rolled steel, roll formed into a 1" x 1-7/8" angle. The wide flange is punched on 1" centers with 7/16" square slots to receive shelf clips and 5/16" diameter holes on 1" centers for the attachment of side sway braces or solid panels.

Model Number	Size	Wt.
OP39	3'3"	2.0
OP51	4'3"	3.0
OP63	5'3"	4.0
OP75	6'3"	4.8
OP87	7'3"	5.5
OP99	8'3"	6.0
OP111	9'3"	7.0
OP123	10'3"	8.0
OP135	11'3"	8.8



ROLLED FORMED POST

A 1-1/4" x 1-1/4" angle made from rolled formed steel with holes punched on 1" centers. All posts are standard 13 gauge (Also available in 12 gauge).

Model Number	Size	Wt.	GA.
RFP39	3'3"	1.8	14
RFP51	4'3"	2.5	14
RFP63	5'3"	2.8	14
RFP75	6'3"	3.6	14
RFP87	7'3"	4.7	13
RFP99	8'3"	5.2	13
RFP111	9'3"	6.1	13
RFP123	10'3"	7.9	12
RFP147	12'3"	9.1	12
RFP171	14'3"	11.9	12
RFP195	16'3"	13.5	12



BOX POST 1-1/2" O.C.

This clip-type post eliminates items being snagged during loading and unloading. Rectangular holes for clips punched on 1-1/2" centers and 5/16" diameter holes 1-1/2" on center as above. Made from 14 gauge cold-rolled steel.

Model Number	Size	Wt.
BP37	3'1"	2.2
BP49	4'1"	3.4
BP61	5'1"	4.5
BP73	6'1"	5.4
BP85	7'1"	6.3
BP97	8'1"	7.2
BP109	9'1"	8.1
BP121	10'1"	9.0



BOX POST 1" O.C.

This clip-type post eliminates items being snagged during loading and unloading. Rectangular holes for clips punched on 1" centers and 5/16" diameter holes 1" on center as above. Made from 14 gauge cold-rolled steel.

Model Number	Size	Wt.
BP39	3'3"	2.2
BP51	4'3"	3.4
BP63	5'3"	4.5
BP75	6'3"	5.4
BP87	7'3"	6.3
BP99	8'3"	7.2
BP111	9'3"	8.1
BP123	10'3"	9.0



GOVERNMENT POST ROLLED FORMED STEEL

13 gauge hot-rolled steel 1" x 1-3/4" with 1" centers.

Model Number	Size	Wt.
GP75	6'3"	4.9
GP87	7'3"	5.7
GP99	8'3"	6.5

STANDARD FOOT PLATES



Model Number
FPBP1
(For use with
1" & 1-1/2" O.C.)



Model Number
FPOP1-D (1" O.C.)



Model Number
FPOP15-D (1-1/2" O.C.)



Model Number
FPOP1-S (L or R) (1" O.C.)



FPOP15-S (L or R) (1-1/2" O.C.) (not pictured)

Tri-Boro Heavy Duty Shelving Posts & Heavy Duty Foot Plates



HEAVY DUTY BOX POST 1" O.C.

Grade 50 Face is .750 x 2.4375
All posts are standard 13 gauge
(Also available in 12 gauge).

Model Number	Size	Wt.
HDBP87-13	7'3"	11.6
HDBP99-13	8'3"	13.3
HDBP111-13	9'3"	14.8
HDBP123-13	10'3"	16.4
HDBP135-13	11'3"	18.0
HDBP147-13	12'3"	19.6
HDBP159-13	13'3"	21.2
HDBP171-13	14'3"	22.8
HDBP183-13	15'3"	24.4
HDBP195-13	16'3"	26.0



HEAVY DUTY OFFSET POST 1" O.C.

Grade 50 Size: 1.375 x 2.063
All posts are standard 13 gauge
(Also available in 12 gauge).

Model Number	Size	Wt.
HDOP87-13	7'3"	7.1
HDOP99-13	8'3"	8.1
HDOP111-13	9'3"	9.1
HDOP123-13	10'3"	10.3
HDOP135-13	11'3"	11.3
HDOP147-13	12'3"	12.0
HDOP159-13	13'3"	13.0
HDOP171-13	14'3"	14.0
HDOP183-13	15'3"	15.0
HDOP195-13	16'3"	15.9

Heavy Duty High Bay Shelving Posts

- Available in 12 & 13 gauge
- Finished heights up to 28' * without splicing
- Available in both offset angle and beaded box post

* Please contact Customer Service for ordering information on sizes above 16'3".

FOOT PLATES



Model Number
FPHDBP1
1" O.C. Heavy Duty Box Post Foot Plate



Model Number
FPHD1-SL
1" O.C. Heavy Duty Offset Post Foot Plate Single Left



Model Number
FPHD1-SR
1" O.C. Heavy Duty Offset Post Foot Plate Single Right



Model Number
FPHD1-D
1" O.C. Heavy Duty Offset Post Foot Plate Double

Shelving with box posts at front and offset angle posts at rear

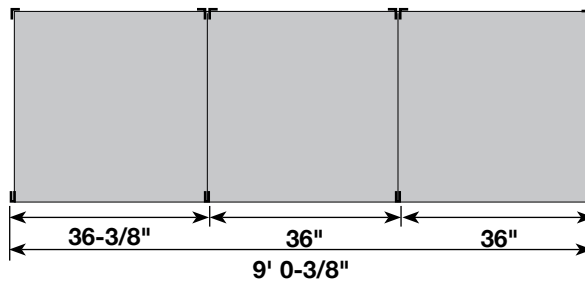

Measurements for HD box post

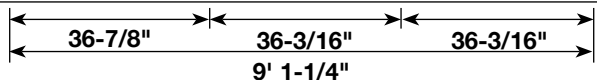

Shelving with offset angle posts front and rear

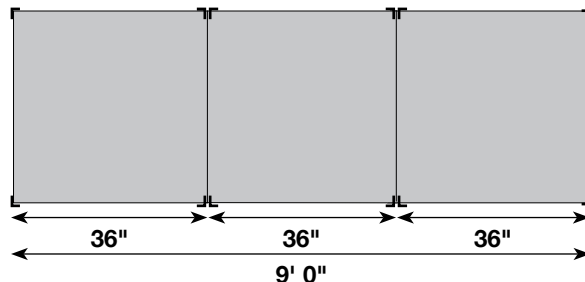

When placing units back to back, omit back panel on 1/2 of the units, thus permitting the use of a common back panel. Same applies to open type, omit 1/2 back sways.

Tri-Boro Flange & Box Shelves



ADJUSTABLE STEEL FLANGE SHELVES (FOR CLIP-TYPE AND NUT AND BOLT)

All shelves are made of 20 or 18 gauge cold rolled steel. Each side has triple bends for added strength.

NOTE: ADD SUFFIX X FOR 18 GAUGE
EXAMPLE: S924X = 18 GAUGE 9" x 24"

Model Number	Size	20 GA. Wt.	18 GA. Wt.
S924	9" x 24"	3.8	5.3
S930	9" x 30"	4.8	6.3
S936	9" x 36"	5.0	7.3
S942	9" x 42"	6.9	8.3
S948	9" x 48"	8.9	9.3
S1224	12" x 24"	4.9	6.4
S1230	12" x 30"	5.0	6.7
S1236	12" x 36"	6.5	8.0
S1242	12" x 42"	8.0	10.3
S1248	12" x 48"	9.0	11.6
S1524	15" x 24"	5.9	7.5
S1530	15" x 30"	6.1	9.0
S1536	15" x 36"	7.1	10.5
S1542	15" x 42"	8.2	12.0
S1548	15" x 48"	9.5	13.5
S1824	18" x 24"	6.9	8.7
S1830	18" x 30"	7.0	10.4
S1836	18" x 36"	8.2	12.1
S1842	18" x 42"	9.5	13.8
S1848	18" x 48"	10.7	15.5
S2124	21" x 24"	8.7	10.0
S2130	21" x 30"	8.9	11.3
S2136	21" x 36"	10.5	14.6
S2142	21" x 42"	12.1	16.9
S2148	21" x 48"	13.7	19.2
S2424	24" x 24"	9.0	11.0
S2430	24" x 30"	9.3	13.3
S2436	24" x 36"	11.0	15.6
S2442	24" x 42"	11.9	17.9
S2448	24" x 48"	13.9	20.2
S3030	30" x 30"	13.0	16.6
S3036	30" x 36"	13.5	18.8
S3042	30" x 42"	14.0	21.6
S3048	30" x 48"	17.5	24.4
S3636	36" x 36"	16.0	22.1
S3642	36" x 42"	18.4	25.4
S3648	36" x 48"	19.5	28.6

NOTE: OTHER SIZES AVAILABLE - PLEASE CALL CUSTOMER SERVICE

BOXER™ (BOX-SHELF) ADJUSTABLE STEEL BOX SHELVES

Shelves are constructed of 18, 20 or 22 gauge steel with full welded box formation in front and back of shelf and have formed channels on both ends. All four corners are lapped and welded for additional strength. The box formation is welded on a 6-inch center minimum to provide integrity to the entire length of the box. All shelves have a box profile height of 1-1/4". All box shelves are designed to accommodate either clip or nut & bolt connection to the upright, and are punched for dividers on 2" centers.

**BOXER™ shelves are compatible with all existing Tri-Boro shelving components.

NOTE: ADD L FOR 22 GAUGE / ADD X FOR 18 GAUGE

Model Number	Size	22 GA. Wt.	20 GA. Wt.	18 GA. Wt.
BX1224	12" x 24"	4.1	4.8	6.3
BX1230	12" x 30"	5.1	5.8	7.1
BX1236	12" x 36"	6.0	7.2	9.1
BX1242	12" x 42"	6.9	8.4	10.4
BX1248	12" x 48"	7.8	9.5	11.8
BX1524	15" x 24"	4.7	5.6	7.2
BX1530	15" x 30"	5.8	6.8	8.9
BX1536	15" x 36"	7.0	8.4	10.5
BX1542	15" x 42"	8.0	9.7	12.2
BX1548	15" x 48"	9.1	11.0	13.8
BX1824	18" x 24"	5.9	6.3	8.3
BX1830	18" x 30"	6.6	7.7	10.2
BX1836	18" x 36"	8.0	9.6	12.1
BX1842	18" x 42"	9.2	11.1	13.9
BX1848	18" x 48"	10.4	12.6	15.8
BX2424	24" x 24"	6.7	7.9	10.0
BX2430	24" x 30"	8.2	9.7	12.0
BX2436	24" x 36"	10.0	12.0	15.1
BX2442	24" x 42"	11.5	13.8	17.4
BX2448	24" x 48"	13.0	15.7	19.7
BX3030	30" x 30"	-	11.6	15.0
BX3036	30" x 36"	-	14.4	18.1
BX3042	30" x 42"	-	16.6	20.9
BX3048	30" x 48"	-	18.8	23.6
BX3636	36" x 36"	-	16.8	22.1
BX3642	36" x 42"	-	19.3	24.3
BX3648	36" x 48"	-	22.0	27.5

NOTE: OTHER SIZES AVAILABLE - PLEASE CALL CUSTOMER SERVICE

Tri-Boro Side & Back Panels

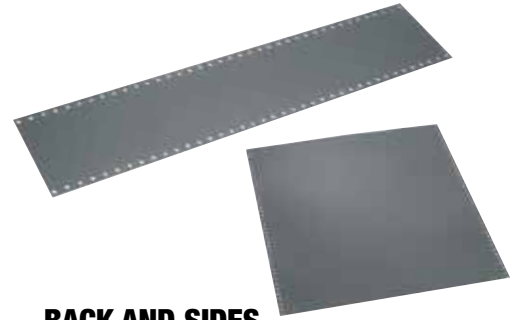

OFFSET SIDES (Clip-Type Shelving - 1" O.C.*) SIDE PANEL - 24 GA.

* Also for use with 1-1/2" O.C.

Made of cold-rolled steel. Punched along edges with 3/8" dia. holes on 1" centers for attaching to front and rear post.

Model Number	Shelf Depth	Dimensions	Wt.
OS639	9"	6" x 39"	2.5
OS645	9"	6" x 45"	2.9
OS651	9"	6" x 51"	3.3
OS939	12"	9" x 39"	3.0
OS945	12"	9" x 45"	4.0
OS951	12"	9" x 51"	5.0
OS1239	15"	12" x 39"	3.5
OS1245	15"	12" x 45"	3.5
OS1251	15"	12" x 51"	5.2
OS1539	18"	15" x 39"	4.5
OS1545	18"	15" x 45"	5.0
OS1551	18"	15" x 51"	6.0
OS1839	21"	18" x 39"	5.7
OS1845	21"	18" x 45"	6.5
OS1851	21"	18" x 51"	7.4
OS2139	24"	21" x 39"	6.0
OS2145	24"	21" x 45"	7.0
OS2151	24"	21" x 51"	8.0
OS2739	30"	27" x 39"	7.5
OS2745	30"	27" x 45"	8.0
OS2751	30"	27" x 51"	9.5
OS3339	36"	33" x 39"	9.0
OS3345	36"	33" x 45"	11.0
OS3351	36"	33" x 51"	12.0
OS4539	48"	45" x 39"	12.0
OS4545	48"	45" x 45"	15.0
OS4551	48"	45" x 51"	16.0

OFFSET BACKS (Clip-Type Shelving - 1" O.C.*) BACK PANEL - 24 GA.

* Also for use with 1-1/2" O.C.

Made of cold-rolled steel. Punched along edges with 3/8" dia. holes on 1" centers for attaching to front and rear post.

Model Number	Shelf Width	Dimensions	Wt.
OB2439	24"	24" x 39"	6.1
OB2445	24"	24" x 45"	7.1
OB2451	24"	24" x 51"	8.1
OB3039	30"	30" x 39"	7.7
OB3045	30"	30" x 45"	9.0
OB3051	30"	30" x 51"	10.2
OB3639	36"	36" x 39"	9.2
OB3645	36"	36" x 45"	10.7
OB3651	36"	36" x 51"	12.2
OB4239	42"	42" x 39"	10.7
OB4245	42"	42" x 45"	12.5
OB4251	42"	42" x 51"	14.2
OB4839	48"	48" x 39"	12.3
OB4845	48"	48" x 45"	14.3
OB4851	48"	48" x 51"	16.3

CLIP-TYPE SHELVING BACK AND SIDE REQUIREMENTS - 1" O.C.

* Also for use with 1-1/2" O.C.

To make the following heights of units follow the chart below to determine number and dimensions of components.

Shelving Height	# of Backs or Sides
5' 3"	= 2 Pieces 39"
6' 3"	= 2 Pieces 39"
7' 3"	= 2 Pieces 45"
8' 3"	= 2 Pieces 51"
9' 3"	= 3 Pieces 39"
10' 3"	= 3 Pieces 45"
11' 3"	= 3 Pieces 51"
12' 3"	= 3 Pieces 51"
14' 3"	= 4 Pieces 45"
16' 3"	= 4 Pieces 51"

BACK AND SIDES (Nut and Bolt Type)

Made of cold-rolled steel. Punched along edges with 3/8" dia. holes on 1" centers for attaching to front and rear post.

Backs over 4' 3" consist of overlapping pieces.

Model Number	Size	Wt.
BS939	9" x 3' 3"	2.5
BS945	9" x 45"	2.9
BS951	9" x 4' 3"	3.3
BS1239	12" x 3' 3"	3.0
BS1245	12" x 45"	4.0
BS1251	12" x 4' 3"	5.0
BS1539	15" x 3' 3"	3.5
BS1545	15" x 45"	3.5
BS1551	15" x 4' 3"	5.2
BS1839	18" x 3' 3"	4.5
BS1845	18" x 45"	5.0
BS1851	18" x 4' 3"	6.0
BS2139	21" x 3' 3"	5.7
BS2145	21" x 45"	6.5
BS2151	21" x 4' 3"	7.4
BS2439	24" x 3' 3"	6.0
BS2445	24" x 45"	7.0
BS2451	24" x 4' 3"	8.0
BS3039	30" x 3' 3"	7.5
BS3045	30" x 45"	8.0
BS3051	30" x 4' 3"	9.5
BS3639	36" x 3' 3"	9.0
BS3645	36" x 45"	11.0
BS3651	36" x 4' 3"	12.0
BS4239	42" x 3' 3"	10.5
BS4245	42" x 45"	13.5
BS4251	42" x 4' 3"	15.0
BS4839	48" x 3' 3"	12.0
BS4845	48" x 45"	15.0
BS4851	48" x 4' 3"	16.0

Special sizes available

Special bending for tables and counters available

NUT & BOLT SHELVING BACK AND SIDE REQUIREMENTS

To make the following heights of units follow the chart below to determine number and dimensions of components.

Shelving Height	# of Backs or Sides	Shelving Height	# of Backs or Sides
5' 3"	= 2 Pieces 39"	10' 3"	= 3 Pieces 45"
6' 3"	= 2 Pieces 39"	11' 3"	= 3 Pieces 51"
7' 3"	= 2 Pieces 45"	12' 3"	= 3 Pieces 51"
8' 3"	= 2 Pieces 51"	14' 3"	= 4 Pieces 45"
9' 3"	= 3 Pieces 39"		

Tri-Boro Sway Braces, Label Holders, Reinforcements, Shelving Clips & Hardware

SWAY BRACES

Made of 1" wide hot-rolled 12 gauge steel strip with safety edges. Ends are radiused and punched for attaching to front and rear post.

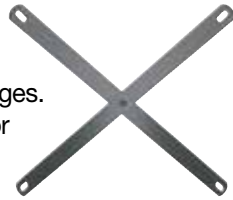

Model Number	Shelf Size	Wt.
SB18	12"-18"	1.0
SB36	24"-36"	2.0
SB48	42"-48"	3.2

General side/back & sway brace info:

When supplying open shelving units, one pair of braces for each side/back location may not always be sufficient. The following is our recommended sway brace to unit height chart. Note: Common sides and backs share sway bracing.

Post height up to 7'	1 pair of sway braces for each side/back location
Post height from 8' to 10'	2 pair of sway braces for each side/back location
Post height from 11' to 13'	3 pair of sway braces for each side/back location
Post height from 14' to 16'	4 pair of sway braces for each side/back location



1-1/2" O.C. (COP15)



1" O.C. (COP1)

CLIPS FOR OFFSET/BOX POSTS

14 gauge (.078 thick) steel zinc plated

Model Number	Wt.
COP15	1 oz.
COP1	1 oz.



LABEL HOLDERS

Made of cold-rolled steel. Punched on ends for attaching to front edge of shelves. The top and bottom edges are folded over to accommodate labels approximately 1" high.

Model Number	Size	Wt.
LH24	24"	.2
LH30	30"	.3
LH36	36"	.4
LH42	42"	.5
LH48	48"	.6

NOTE: Welded Label Holders Available for flange shelves only.



REINFORCEMENTS

A 1" x 1" angle made of 12 gauge steel used to reinforce front and /or back of shelf.

Model Number	Size	Wt.
RB18	18"	.7
RB21	21"	1.0
RB24	24"	1.4
RB30	30"	1.7
RB36	36"	2.0
RB42	42"	2.4
RB48	48"	2.7



ROUNDHEAD BOLTS WITH HEX NUTS

(Sold in boxes of 100)

Model Number	Size	Quantity	Wt.
HB63	1/4" x 5/8"	100	2
HB100	1/4" X 1"	100	2.5
HB125	1/4" X 1-1/4"	100	3

Tri-Boro Angle Sways & Splices

ANGLE SWAYS (For 1" on Center Offset and Nut & Bolt Shelving)



A 5" x 5" L-shaped bracket that is made of 11 gauge steel with holes punched 2" on center. Gives 5 points of fastening between shelf and upright to prevent lateral movement when sway bracing is not used.

Model Number	Size	Wt.
AN55	5" x 5"	.02

OFFSET ANGLE SWAYS (For 1-1/2" on Center Shelving)



A 5" x 5" L-shaped bracket made of 11 gauge steel with one leg punched on 2" centers and the other punched 1-1/2" on center. Gives 5 points of fastening between shelf and upright to prevent lateral movement when sway bracing is not used.

Model Number	Size	Wt.
OAS55	5" x 5"	.2

SPLICE (For Rolled Formed Post)



Made of hot-rolled 12 gauge steel. Punched 2" on center for the joining of two roll form posts. Dimensions of splice are 1" x 1" x 7".

Model Number	Wt.
SP 117	.32

OFFSET SPLICE

Made from cold-rolled 12 gauge steel. Punched on 1-1/2" and 1" on centers from either end for the joining of two offset posts. Dimensions of splice are 3/4" x 1" x 5".

Model Number	Wt.
OSP115	.18
OSP1	.18



1-1/2" O.C.

1" O.C.



BOX POST SPLICE

Made from cold-rolled 12 gauge steel. Punched on 1-1/2" and 1" on centers from either end for the joining of two box posts.

Model Number	Wt.	Dimensions
OSP 115	0.2	4.5" x 1.775"
OSP 1	0.2	5.5" x 1.775"

HEAVY DUTY OFFSET POST SPLICE

Made from cold-rolled 12 gauge steel. Punched on 1" on centers from either end for the joining of two heavy duty offset posts.

Model Number	Wt.	Dimensions
HDOSP 1	0.4	7" x 1.875" x 1.223"

HEAVY DUTY BOX POST SPLICE

Made from cold-rolled 12 gauge steel. Punched on 1" on centers from either end for the joining of two heavy duty box posts.

Model Number	Wt.	Dimensions
HDBSP 1	0.4	7.5" x 1.775"

Tri-Boro Shelving Bin Fronts



BIN FRONTS (Nut and Bolt Shelving)

Made of cold rolled 18 gauge steel. Top edge is formed into a hem. Bottom is flanged to rest on shelf and punched to provide means of attaching to post.

Model Number	Size H x W	Wt.
BF224	2" x 24"	.9
BF230	2" x 30"	1.2
BF236	2" x 36"	1.4
BF242	2" x 42"	1.6
BF248	2" x 48"	1.8
BF424	4" x 24"	1.6
BF430	4" x 30"	2.0
BF436	4" x 36"	2.5
BF442	4" x 42"	2.8
BF448	4" x 48"	3.2
BF624	6" x 24"	2.3
BF630	6" x 30"	2.8
BF636	6" x 36"	4.0
BF642	6" x 42"	4.4
BF648	6" x 48"	5.1



OFFSET BIN FRONTS (Clip-Type Shelving 1-1/2" O.C.)

Made from 18 gauge steel

Model Number	Size H x W	Wt.
OBF124	1-1/2" x 24"	.6
OBF130	1-1/2" x 30"	.8
OBF136	1-1/2" x 36"	.9
OBF142	1-1/2" x 42"	1.1
OBF148	1-1/2" x 48"	1.9
OBF324	3" x 24"	.9
OBF330	3" x 30"	1.2
OBF336	3" x 36"	1.4
OBF342	3" x 42"	1.7
OBF348	3" x 48"	1.9
OBF624	6" x 24"	1.1
OBF630	6" x 30"	1.4
OBF636	6" x 36"	1.6
OBF642	6" x 42"	1.9
OBF648	6" x 48"	2.2



OFFSET BIN FRONTS (Clip-Type Shelving 1" O.C.)

Made from 20 gauge steel

Model Number	Size H x W	Wt.
OBF224	2" x 24"	.9
OBF230	2" x 30"	1.2
OBF236	2" x 36"	1.4
OBF242	2" x 42"	1.6
OBF248	2" x 48"	1.8
OBF424	4" x 24"	1.6
OBF430	4" x 30"	2.0
OBF436	4" x 36"	2.5
OBF442	4" x 42"	2.8
OBF448	4" x 48"	3.2
OBF624	6" x 24"	2.3
OBF630	6" x 30"	2.8
OBF636	6" x 36"	4.0
OBF642	6" x 42"	4.4
OBF648	6" x 48"	5.1



OFFSET BIN FRONTS BOX POST (Clip-Type Shelving 1-1/2" O.C.)

Made from 18 gauge steel

Model Number	Size H x W	Wt.
OBBP324	3" x 24"	.9
OBBF330	3" x 30"	1.2
OBBF336	3" x 36"	1.4
OBBF342	3" x 42"	1.6
OBBF348	3" x 48"	1.9



OFFSET BIN FRONTS BOX POST (Clip-Type Shelving 1" O.C.)

Made from 18 gauge steel

Model Number	Size H x W	Wt.
OBBP224	2" x 24"	.9
OBBF230	2" x 30"	1.2
OBBF236	2" x 36"	1.4
OBBF242	2" x 42"	1.6
OBBF248	2" x 48"	1.8

Tri-Boro Shelving Bases & Aisle Braces

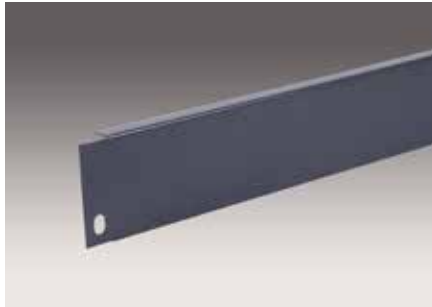

UNIVERSAL BASES (For Clip and Nut & Bolt Shelving)

Made of cold-rolled steel. Channel formed to fit between shelf and floor. Punched for bolting to holes in front flange of post.

Model Number	Size	Wt.
OBS224	2" x 24"	.9
OBS230	2" x 30"	1.2
OBS236	2" x 36"	1.4
OBS242	2" x 42"	1.6
OBS248	2" x 48"	1.8
OBS324	3" x 24"	.9
OBS330	3" x 30"	1.2
OBS336	3" x 36"	1.2
OBS342	3" x 42"	1.7
OBS348	3" x 48"	1.9

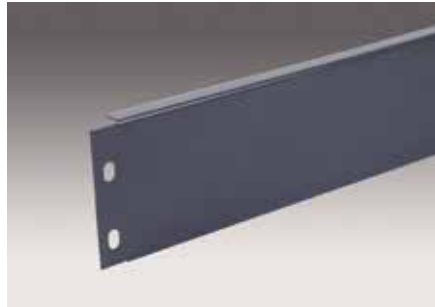

BASES (Nut & Bolt Shelving)

Made of cold-rolled 18 gauge steel. Channel formed to fit between shelf and floor. Pierced for bolting to holes in front flange of post. Bases 4" and higher are punched 2" on center.

Model Number	Size	Wt.
BAS412	4" x 12"	.8
BAS415	4" x 15"	.8
BAS418	4" x 18"	.8
BAS424	4" x 24"	1.6
BAS430	4" x 30"	2.0
BAS436	4" x 36"	2.5
BAS442	4" x 42"	2.8
BAS448	4" x 48"	3.2
BAS612	6" x 12"	1.1
BAS615	6" x 15"	1.1
BAS618	6" x 18"	1.1
BAS624	6" x 24"	2.3
BAS630	6" x 30"	2.8
BAS636	6" x 36"	4.0
BAS642	6" x 42"	4.4
BAS648	6" x 48"	5.1



OFFSET BASES FOR BOX POST (Clip-Type Shelving 1-1/2" O.C.)

Made of cold-rolled 18 gauge steel.

Model Number	Size	Wt.
OBB324	3" x 24"	.9
OBB330	3" x 30"	1.2
OBB336	3" x 36"	1.4
OBB342	3" x 42"	1.7
OBB348	3" x 48"	1.9



OFFSET BASES FOR BOX POST (Clip-Type Shelving 1" O.C.)

Model Number	Size	Wt.
OBB224	2" x 24"	.9
OBB230	2" x 30"	1.2
OBB236	2" x 36"	1.4
OBB242	2" x 42"	1.6
OBB248	2" x 48"	1.8

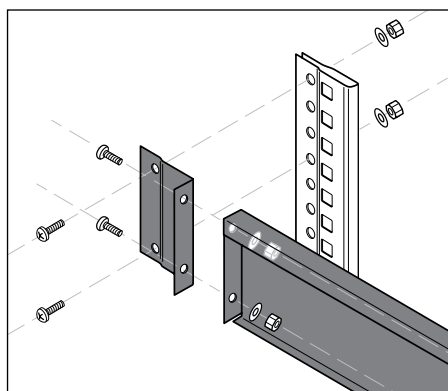

OFFSET AISLE BRACES FOR BOX POST Includes aisle brace, adapter & hardware

Model Number	Size	Wt.
BAB1-30	30"	5
BAB1-36	36"	5.8
BAB1-42	42"	6.7
BAB1-48	48"	7.5
BAB15-30	30"	5
BAB15-36	36"	5.8
BAB15-42	42"	6.7
BAB15-48	48"	7.5



OFFSET AISLE BRACES (Clip-Type Shelving)

Made of 13 gauge channel formed steel with one additional return flange on top for added strength. End tabs are flanged at 90° angles with holes punched on 1-1/2" centers.

Model Number	Size	Wt.
OAB30	30"	4.6
OAB36	36"	5.4
OAB42	42"	6.3
OAB48	48"	7.1



AISLE BRACES (Nut & Bolt Shelving)

Made of 13 gauge channel formed steel with one additional return flange on top for added strength. End tabs are flanged at 90° angles with holes punched on 2" centers.

Model Number	Size	Wt.
AB30	30"	4.6
AB36	36"	5.4
AB42	42"	6.3
AB48	48"	7.1

Tri-Boro Bin Dividers, Shelf Boxes & Shelf Box Dividers



SLIDING DIVIDERS

Made of cold-rolled 18 gauge steel. Top corners are rounded for safety. Bottom is flanged for attachment to shelf, without hardware, allowing for horizontal mobility.

Model Number	Size H x D	Wt.
SD412	4" x 12"	1.2
SD415	4" x 15"	1.5
SD418	4" x 18"	1.7
SD424	4" x 24"	2.2
SD612	6" x 12"	1.7
SD615	6" x 15"	1.8
SD618	6" x 18"	1.9
SD624	6" x 24"	2.5
SD812	8" x 12"	2.0
SD815	8" x 15"	2.05
SD818	8" x 18"	2.1
SD824	8" x 24"	2.8

Optional label holder: add -LH to part number.



CLIPS FOR BIN DIVIDERS*

Model Number	Wt.
CBDIV	8 oz. per 100

* Please specify: Clear for box shelves, Black for perforated flange shelves - same model number



BIN DIVIDERS

Made of cold rolled 24 gauge steel. Front and back edges are rolled to provide rigidity. Top and bottom are flanged and punched for attachment to shelves. Dividers are installed with snap-in spring-type clips.



Model Number	Size H x D	Wt.
BD612	6" x 12"	.8
BD615	6" x 15"	1.1
BD618	6" x 18"	1.3
BD624	6" x 24"	1.6
BD812	8" x 12"	1.0
BD815	8" x 15"	1.6
BD818	8" x 18"	1.9
BD824	8" x 24"	2.5
BD912	9" x 12"	.9
BD915	9" x 15"	1.1
BD918	9" x 18"	1.3
BD924	9" x 24"	1.8
BD1012	10" x 12"	1.0
BD1015	10" x 15"	1.6
BD1018	10" x 18"	1.9
BD1024	10" x 24"	2.5
BD1212	12" x 12"	1.3
BD1215	12" x 15"	2.0
BD1218	12" x 18"	2.5
BD1224	12" x 24"	2.9
BD1412	14" x 12"	1.7
BD1415	14" x 15"	2.1
BD1418	14" x 18"	2.5
BD1424	14" x 24"	2.9
BD1512	15" x 12"	1.3
BD1515	15" x 15"	1.7
BD1518	15" x 18"	2.0
BD1524	15" x 24"	2.7
BD1612	16" x 12"	1.9
BD1615	16" x 15"	2.2
BD1618	16" x 18"	2.8
BD1624	16" x 24"	3.8
BD1812	18" x 12"	1.6
BD1815	18" x 15"	2.0
BD1818	18" x 18"	2.4
BD1824	18" x 24"	3.3



SHELF BOXES

Front and rear panels are made of 20 gauge steel to help prevent unsightly dings. Body of box is made of 22 gauge steel. Front panel has built-in handle and 2" label holder. All boxes are 4-5/8" high. Dividers are not included but may be added as an option.

Model Number	Size W x H x D	Wt.
SB5410	5-1/2" x 4-5/8" x 10-7/8"	2.16
SB8410	8-1/4" x 4-5/8" x 10-7/8"	2.68
SB11410	11" x 4-5/8" x 10-7/8"	3.28
SB5416	5-1/2" x 4-5/8" x 16-7/8"	3.02
SB8416	8-1/4" x 4-5/8" x 16-7/8"	3.75
SB11416	11" x 4-5/8" x 16-7/8"	4.59
SB5422	5-1/2" x 4-5/8" x 22-7/8"	3.89
SB8422	8-1/4" x 4-5/8" x 22-7/8"	4.82
SB11422	11" x 4-5/8" x 22-7/8"	5.9



Optional label holder

Contact Customer Service for how to order

SHELF BOX DIVIDERS

Made of 22 gauge steel.

Model Number	Size	Wt.
SBD5	5"	.0
SBD8	8"	.5
SBD11	11"	1.0

Tri-Boro Shelving Parts Identification & Quick Page Reference

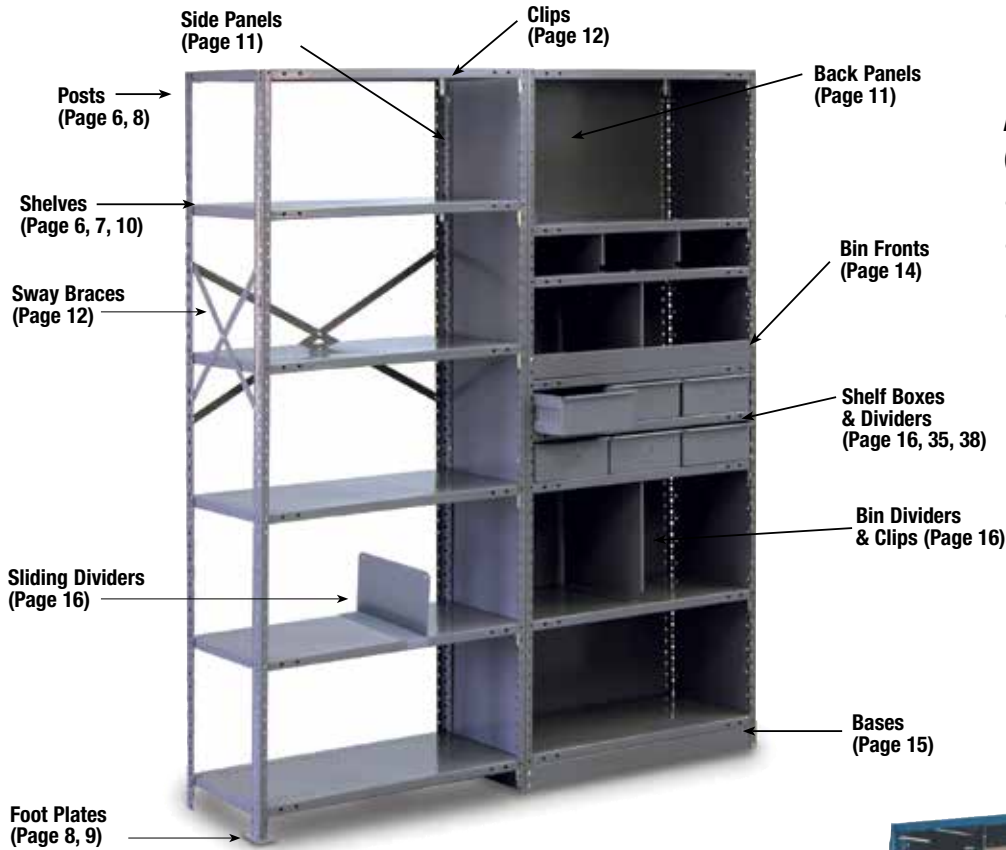

Additional Parts (Not Shown)

- Splices, Angle Sways (Page 13)
- Shelf Reinforcements, Label Holders (Page 12-13)
- Aisle Braces (Page 15)

AUTOMOTIVE SHELVING

Automotive Unit and Accessories	Weight	Part No.
Basic Unit: 12"D x 36"W x 84"H (10 Shelf)	105.0	A361284
Components:		
Extra Slide-In Shelf: 12"D x 36"W	5.5	AS3612
Upright: 12"D x 84"H	15.3	AU1284
Back: 36"W x 49"H	18.0	AB3649
Base: 36"W x 3"H	1.4	AB36
Accessories:		
3" Sliding Parts Divider: 12"D x 3"H	1.2	ASD312
3" Sliding Parts Divider: 12"D x 3"H w/label holder Sky White	1.3	ASD312-LH
8" Sliding Parts Divider 12"D x 8"H w/label holder Sky White	2.1	ASD812-LH
Shelf Box: 10-7/8"D x 5-1/2"W x 4-5/8"H	2.2	ASB5410
Shelf Box Divider: 5"W x 4-3/8"H	0.3	ASBD5
Automotive Label Holder 36" W	0.6	ALH36

 Unit Color: Blue

 Back & Accessories Color: Sky White

Sliding Parts Divider shown with optional label holder



Automotive Unit with Accessories

Tri-Boro Starter and Add-On Shelving Configurations



Cross Braces on both sides indicates starter



7 SHELVES

36" WIDE x 7' 1" HIGH

Depth	Starter Unit No.	Add On Unit No.
12"	OSB 85-1236-7	OAB 85-1236-7
15"	OSB 85-1536-7	OAB 85-1536-7
18"	OSB 85-1836-7	OAB 85-1836-7
24"	OSB 85-2436-7	OAB 85-2436-7
30"	OSB 85-3036-7	OAB 85-3036-7

Unit Type
 B=Boxer
 K=Klip-It
 T=Thunderbolt

Unit Height
 Unit Depth
 Unit Width
 Number of Shelves

OS OPEN TYPE STARTER UNIT

Each OS unit is complete consisting of:

- Open Type - Starter Unit
- Any number of shelves
- Four uprights
- Two pair of side sway braces
- One pair of back sway braces
- Necessary nuts and bolts or clips

OA OPEN TYPE ADD-ON UNIT

Each OA unit is complete consisting of:

- Open Type - Add On Unit
- Any number of shelves
- Four uprights
- One pair of back sway braces
- One pair of side sway braces
- Necessary nuts and bolts or clips



Sides on both ends indicates starter



7 SHELVES

36" WIDE x 7' 1" HIGH

Depth	Starter Unit No.	Add On Unit No.
12"	CSB 85-1236-7	CAB 85-1236-7
15"	CSB 85-1536-7	CAB 85-1536-7
18"	CSB 85-1836-7	CAB 85-1836-7
24"	CSB 85-2436-7	CAB 85-2436-7
30"	CSB 85-3036-7	CAB 85-3036-7

CS CLOSED TYPE STARTER UNIT

Each CS unit is complete consisting of:

- Closed Type - Starter Unit
- Any number of shelves
- Four uprights
- Two closed sides
- One closed back
- One base
- Necessary nuts and bolts or clips

CA CLOSED TYPE ADD-ON UNIT

Each CA unit is complete consisting of:

- Closed Type - Add On Unit
- Any number of shelves
- Four uprights
- One closed side
- One closed back
- One base
- Necessary nuts and bolts or clips

Tri-Boro Open & Closed Type Shelving Units



Note: Dimensions are for posts 1-1/2" on centers – Dimensions for posts on 1" centers will be different.

NOTE: Add 2" to the height of each unit for Thunderbolt, i.e. 6'1" Boxer & Klip-It = 6'3" Thunderbolt

Shelving Units Also Available With Offset Posts 1" On Centers (See Page 12) and Clip (See Page 20)

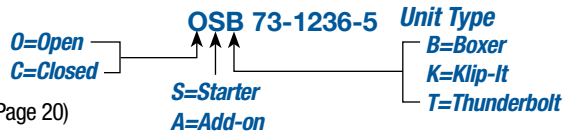

6'1" HIGH OPEN TYPE • BOXER™ (BOX-SHELF): 22 GA., 20 GA. and 18 GA.
UNIT NUMBERS ON THIS PAGE ARE 20 GA. – ADD L FOR 22 GA., X FOR 18 GA.

Note: 36" Deep Shelving Available. See price list for components

5 SHELVES 36" WIDE x 6' 1" HIGH

Depth	Starter Unit No.	Add On Unit No.
12"	OSB 73-1236-5	OAB 73-1236-5
15"	OSB 73-1536-5	OAB 73-1536-5
18"	OSB 73-1836-5	OAB 73-1836-5
24"	OSB 73-2436-5	OAB 73-2436-5
30"	OSB 73-3036-5	OAB 73-3036-5

6 SHELVES 36" WIDE x 6' 1" HIGH

Depth	Starter Unit No.	Add On Unit No.
12"	OSB 73-1236-6	OAB 73-1236-6
15"	OSB 73-1536-6	OAB 73-1536-6
18"	OSB 73-1836-6	OAB 73-1836-6
24"	OSB 73-2436-6	OAB 73-2436-6
30"	OSB 73-3036-6	OAB 73-3036-6

7 SHELVES 36" WIDE x 6' 1" HIGH

Depth	Starter Unit No.	Add On Unit No.
12"	OSB 73-1236-7	OAB 73-1236-7
15"	OSB 73-1536-7	OAB 73-1536-7
18"	OSB 73-1836-7	OAB 73-1836-7
24"	OSB 73-2436-7	OAB 73-2436-7
30"	OSB 73-3036-7	OAB 73-3036-7

42" WIDE x 6' 1" HIGH

Depth	Starter Unit No.	Add On Unit No.
12"	OSB 73-1242-5	OAB 73-1242-5
15"	OSB 73-1542-5	OAB 73-1542-5
18"	OSB 73-1842-5	OAB 73-1842-5
24"	OSB 73-2442-5	OAB 73-2442-5
30"	OSB 73-3042-5	OAB 73-3042-5

42" WIDE x 6' 1" HIGH

Depth	Starter Unit No.	Add On Unit No.
12"	OSB 73-1242-6	OAB 73-1242-6
15"	OSB 73-1542-6	OAB 73-1542-6
18"	OSB 73-1842-6	OAB 73-1842-6
24"	OSB 73-2442-6	OAB 73-2442-6
30"	OSB 73-3042-6	OAB 73-3042-6

42" WIDE x 6' 1" HIGH

Depth	Starter Unit No.	Add On Unit No.
12"	OSB 73-1242-7	OAB 73-1242-7
15"	OSB 73-1542-7	OAB 73-1542-7
18"	OSB 73-1842-7	OAB 73-1842-7
24"	OSB 73-2442-7	OAB 73-2442-7
30"	OSB 73-3042-7	OAB 73-3042-7

48" WIDE x 6' 1" HIGH

Depth	Starter Unit No.	Add On Unit No.
12"	OSB 73-1248-5	OAB 73-1248-5
15"	OSB 73-1548-5	OAB 73-1548-5
18"	OSB 73-1848-5	OAB 73-1848-5
24"	OSB 73-2448-5	OAB 73-2448-5
30"	OSB 73-3048-5	OAB 73-3048-5

48" WIDE x 6' 1" HIGH

Depth	Starter Unit No.	Add On Unit No.
12"	OSB 73-1248-6	OAB 73-1248-6
15"	OSB 73-1548-6	OAB 73-1548-6
18"	OSB 73-1848-6	OAB 73-1848-6
24"	OSB 73-2448-6	OAB 73-2448-6
30"	OSB 73-3048-6	OAB 73-3048-6

48" WIDE x 6' 1" HIGH

Depth	Starter Unit No.	Add On Unit No.
12"	OSB 73-1248-7	OAB 73-1248-7
15"	OSB 73-1548-7	OAB 73-1548-7
18"	OSB 73-1848-7	OAB 73-1848-7
24"	OSB 73-2448-7	OAB 73-2448-7
30"	OSB 73-3048-7	OAB 73-3048-7

6' 1" HIGH CLOSED TYPE • BOXER™ (BOX-SHELF): 22 GA., 20 GA. and 18 GA.
UNIT NUMBERS ON THIS PAGE ARE 20 GA. – ADD L FOR 22 GA., X FOR 18 GA.

5 SHELVES 36" WIDE x 6'1" HIGH

Depth	Starter Unit No.	Add On Unit No.
12"	CSB 73-1236-5	CAB 73-1236-5
15"	CSB 73-1536-5	CAB 73-1536-5
18"	CSB 73-1836-5	CAB 73-1836-5
24"	CSB 73-2436-5	CAB 73-2436-5
30"	CSB 73-3036-5	CAB 73-3036-5

6 SHELVES 36" WIDE x 6' 1" HIGH

Depth	Starter Unit No.	Add On Unit No.
12"	CSB 73-1236-6	CAB 73-1236-6
15"	CSB 73-1536-6	CAB 73-1536-6
18"	CSB 73-1836-6	CAB 73-1836-6
24"	CSB 73-2436-6	CAB 73-2436-6
30"	CSB 73-3036-6	CAB 73-3036-6

7 SHELVES 36" WIDE x 6' 1" HIGH

Depth	Starter Unit No.	Add On Unit No.
12"	CSB 73-1236-7	CAB 73-1236-7
15"	CSB 73-1536-7	CAB 73-1536-7
18"	CSB 73-1836-7	CAB 73-1836-7
24"	CSB 73-2436-7	CAB 73-2436-7
30"	CSB 73-3036-7	CAB 73-3036-7

42" WIDE x 6' 1" HIGH

Depth	Starter Unit No.	Add On Unit No.
12"	CSB 73-1242-5	CAB 73-1242-5
15"	CSB 73-1542-5	CAB 73-1542-5
18"	CSB 73-1842-5	CAB 73-1842-5
24"	CSB 73-2442-5	CAB 73-2442-5
30"	CSB 73-3042-5	CAB 73-3042-5

42" WIDE x 6' 1" HIGH

Depth	Starter Unit No.	Add On Unit No.
12"	CSB 73-1242-6	CAB 73-1242-6
15"	CSB 73-1542-6	CAB 73-1542-6
18"	CSB 73-1842-6	CAB 73-1842-6
24"	CSB 73-2442-6	CAB 73-2442-6
30"	CSB 73-3042-6	CAB 73-3042-6

42" WIDE x 6' 1" HIGH

Depth	Starter Unit No.	Add On Unit No.
12"	CSB 73-1242-7	CAB 73-1242-7
15"	CSB 73-1542-7	CAB 73-1542-7
18"	CSB 73-1842-7	CAB 73-1842-7
24"	CSB 73-2442-7	CAB 73-2442-7
30"	CSB 73-3042-7	CAB 73-3042-7

48" WIDE x 6' 1" HIGH

Depth	Starter Unit No.	Add On Unit No.
12"	CSB 73-1248-5	CAB 73-1248-5
15"	CSB 73-1548-5	CAB 73-1548-5
18"	CSB 73-1848-5	CAB 73-1848-5
24"	CSB 73-2448-5	CAB 73-2448-5
30"	CSB 73-3048-5	CAB 73-3048-5

48" WIDE x 6'1" HIGH

Depth	Starter Unit No.	Add On Unit No.
12"	CSB 73-1248-6	CAB 73-1248-6
15"	CSB 73-1548-6	CAB 73-1548-6
18"	CSB 73-1848-6	CAB 73-1848-6
24"	CSB 73-2448-6	CAB 73-2448-6
30"	CSB 73-3048-6	CAB 73-3048-6

48" WIDE x 6' 1" HIGH

Depth	Starter Unit No.	Add On Unit No.
12"	CSB 73-1248-7	CAB 73-1248-7
15"	CSB 73-1548-7	CAB 73-1548-7
18"	CSB 73-1848-7	CAB 73-1848-7
24"	CSB 73-2448-7	CAB 73-2448-7
30"	CSB 73-3048-7	CAB 73-3048-7

Tri-Boro Open & Closed Type Shelving Units



Note: Dimensions are for posts 1-1/2" on centers – Dimensions for posts on 1" centers will be different.

NOTE: Add 2" to the height of each unit for Thunderbolt, i.e. 6'1" Boxer & Klip-It = 6'3" Thunderbolt

Shelving Units Also Available With Offset Posts 1" On Centers (See Page 12) and Clip (See Page 20)

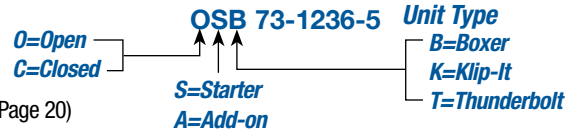

7' 1" HIGH OPEN TYPE • BOXER™ (BOX-SHELF): 22 GA., 20 GA. and 18 GA.

UNIT NUMBERS ON THIS PAGE ARE 20 GA. – ADD L FOR 22 GA., X FOR 18 GA.

Note: 36" Deep Shelving Available. See price list for components

5 SHELVES 36" WIDE x 7' 1" HIGH

Depth	Starter Unit No.	Add On Unit No.
12"	OSB 85-1236-5	OAB 85-1236-5
15"	OSB 85-1536-5	OAB 85-1536-5
18"	OSB 85-1836-5	OAB 85-1836-5
24"	OSB 85-2436-5	OAB 85-2436-5
30"	OSB 85-3036-5	OAB 85-3036-5

6 SHELVES 36" WIDE x 7' 1" HIGH

Depth	Starter Unit No.	Add On Unit No.
12"	OSB 85-1236-6	OAB 85-1236-6
15"	OSB 85-1536-6	OAB 85-1536-6
18"	OSB 85-1836-6	OAB 85-1836-6
24"	OSB 85-2436-6	OAB 85-2436-6
30"	OSB 85-3036-6	OAB 85-3036-6

7 SHELVES 36" WIDE x 7' 1" HIGH

Depth	Starter Unit No.	Add On Unit No.
12"	OSB 85-1236-7	OAB 85-1236-7
15"	OSB 85-1536-7	OAB 85-1536-7
18"	OSB 85-1836-7	OAB 85-1836-7
24"	OSB 85-2436-7	OAB 85-2436-7
30"	OSB 85-3036-7	OAB 85-3036-7

42" WIDE x 7' 1" HIGH

Depth	Starter Unit No.	Add On Unit No.
12"	OSB 85-1242-5	OAB 85-1242-5
15"	OSB 85-1542-5	OAB 85-1542-5
18"	OSB 85-1842-5	OAB 85-1842-5
24"	OSB 85-2442-5	OAB 85-2442-5
30"	OSB 85-3042-5	OAB 85-3042-5

42" WIDE x 7' 1" HIGH

Depth	Starter Unit No.	Add On Unit No.
12"	OSB 85-1242-6	OAB 85-1242-6
15"	OSB 85-1542-6	OAB 85-1542-6
18"	OSB 85-1842-6	OAB 85-1842-6
24"	OSB 85-2442-6	OAB 85-2442-6
30"	OSB 85-3042-6	OAB 85-3042-6

42" WIDE x 7' 1" HIGH

Depth	Starter Unit No.	Add On Unit No.
12"	OSB 85-1242-7	OAB 85-1242-7
15"	OSB 85-1542-7	OAB 85-1542-7
18"	OSB 85-1842-7	OAB 85-1842-7
24"	OSB 85-2442-7	OAB 85-2442-7
30"	OSB 85-3042-7	OAB 85-3042-7

48" WIDE x 7' 1" HIGH

Depth	Starter Unit No.	Add On Unit No.
12"	OSB 85-1248-5	OAB 85-1248-5
15"	OSB 85-1548-5	OAB 85-1548-5
18"	OSB 85-1848-5	OAB 85-1848-5
24"	OSB 85-2448-5	OAB 85-2448-5
30"	OSB 85-3048-5	OAB 85-3048-5

48" WIDE x 7' 1" HIGH

Depth	Starter Unit No.	Add On Unit No.
12"	OSB 85-1248-6	OAB 85-1248-6
15"	OSB 85-1548-6	OAB 85-1548-6
18"	OSB 85-1848-6	OAB 85-1848-6
24"	OSB 85-2448-6	OAB 85-2448-6
30"	OSB 85-3048-6	OAB 85-3048-6

48" WIDE x 7' 1" HIGH

Depth	Starter Unit No.	Add On Unit No.
12"	OSB 85-1248-7	OAB 85-1248-7
15"	OSB 85-1548-7	OAB 85-1548-7
18"	OSB 85-1848-7	OAB 85-1848-7
24"	OSB 85-2448-7	OAB 85-2448-7
30"	OSB 85-3048-7	OAB 85-3048-7

7' 1" HIGH CLOSED TYPE • BOXER™ (BOX-SHELF): 22 GA., 20 GA. and 18 GA.

UNIT NUMBERS ON THIS PAGE ARE 20 GA. – ADD L FOR 22 GA., X FOR 18 GA.

5 SHELVES 36" WIDE x 7' 1" HIGH

Depth	Starter Unit No.	Add On Unit No.
12"	CSB 85-1236-5	CAB 85-1236-5
15"	CSB 85-1536-5	CAB 85-1536-5
18"	CSB 85-1836-5	CAB 85-1836-5
24"	CSB 85-2436-5	CAB 85-2436-5
30"	CSB 85-3036-5	CAB 85-3036-5

6 SHELVES 36" WIDE x 7' 1" HIGH

Depth	Starter Unit No.	Add On Unit No.
12"	CSB 85-1236-6	CAB 85-1236-6
15"	CSB 85-1536-6	CAB 85-1536-6
18"	CSB 85-1836-6	CAB 85-1836-6
24"	CSB 85-2436-6	CAB 85-2436-6
30"	CSB 85-3036-6	CAB 85-3036-6

7 SHELVES 36" WIDE x 7' 1" HIGH

Depth	Starter Unit No.	Add On Unit No.
12"	CSB 85-1236-7	CAB 85-1236-7
15"	CSB 85-1536-7	CAB 85-1536-7
18"	CSB 85-1836-7	CAB 85-1836-7
24"	CSB 85-2436-7	CAB 85-2436-7
30"	CSB 85-3036-7	CAB 85-3036-7

42" WIDE x 7' 1" HIGH

Depth	Starter Unit No.	Add On Unit No.
12"	CSB 85-1242-5	CAB 85-1242-5
15"	CSB 85-1542-5	CAB 85-1542-5
18"	CSB 85-1842-5	CAB 85-1842-5
24"	CSB 85-2442-5	CAB 85-2442-5
30"	CSB 85-3042-5	CAB 85-3042-5

42" WIDE x 7' 1" HIGH

Depth	Starter Unit No.	Add On Unit No.
12"	CSB 85-1242-6	CAB 85-1242-6
15"	CSB 85-1542-6	CAB 85-1542-6
18"	CSB 85-1842-6	CAB 85-1842-6
24"	CSB 85-2442-6	CAB 85-2442-6
30"	CSB 85-3042-6	CAB 85-3042-6

42" WIDE x 7' 1" HIGH

Depth	Starter Unit No.	Add On Unit No.
12"	CSB 85-1242-7	CAB 85-1242-7
15"	CSB 85-1542-7	CAB 85-1542-7
18"	CSB 85-1842-7	CAB 85-1842-7
24"	CSB 85-2442-7	CAB 85-2442-7
30"	CSB 85-3042-7	CAB 85-3042-7

48" WIDE x 7' 1" HIGH

Depth	Starter Unit No.	Add On Unit No.
12"	CSB 85-1248-5	CAB 85-1248-5
15"	CSB 85-1548-5	CAB 85-1548-5
18"	CSB 85-1848-5	CAB 85-1848-5
24"	CSB 85-2448-5	CAB 85-2448-5
30"	CSB 85-3048-5	CAB 85-3048-5

48" WIDE x 7' 1" HIGH

Depth	Starter Unit No.	Add On Unit No.
12"	CSB 85-1248-6	CAB 85-1248-6
15"	CSB 85-1548-6	CAB 85-1548-6
18"	CSB 85-1848-6	CAB 85-1848-6
24"	CSB 85-2448-6	CAB 85-2448-6
30"	CSB 85-3048-6	CAB 85-3048-6

48" WIDE x 7' 1" HIGH

Depth	Starter Unit No.	Add On Unit No.
12"	CSB 85-1248-7	CAB 85-1248-7
15"	CSB 85-1548-7	CAB 85-1548-7
18"	CSB 85-1848-7	CAB 85-1848-7
24"	CSB 85-2448-7	CAB 85-2448-7
30"	CSB 85-3048-7	CAB 85-3048-7

Tri-Boro Open & Closed Type Shelving Units



Note: Dimensions are for posts 1-1/2" on centers – Dimensions for posts on 1" centers will be different.

NOTE: Add 2" to the height of each unit for Thunderbolt,

i.e. 6'1" Boxer & Klip-It = 6'3" Thunderbolt

Shelving Units Also Available With Offset Posts 1" On Centers (See Page 12) and Clip (See Page 20)

8' 1" HIGH OPEN TYPE • BOXER™ (BOX-SHELF): 22 GA., 20 GA. and 18 GA.
UNIT NUMBERS ON THIS PAGE ARE 20 GA. – ADD L FOR 22 GA., X FOR 18 GA.

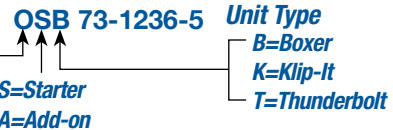

Note: 36" Deep Shelving Available.
See price list for components

5 SHELVES 36" WIDE x 8' 1" HIGH

Depth	Starter Unit No.	Add On Unit No.
12"	OSB 97-1236-5	OAB 97-1236-5
15"	OSB 97-1536-5	OAB 97-1536-5
18"	OSB 97-1836-5	OAB 97-1836-5
24"	OSB 97-2436-5	OAB 97-2436-5
30"	OSB 97-3036-5	OAB 97-3036-5

42" WIDE x 8' 1" HIGH

Depth	Starter Unit No.	Add On Unit No.
12"	OSB 97-1242-5	OAB 97-1242-5
15"	OSB 97-1542-5	OAB 97-1542-5
18"	OSB 97-1842-5	OAB 97-1842-5
24"	OSB 97-2442-5	OAB 97-2442-5
30"	OSB 97-3042-5	OAB 97-3042-5

48" WIDE x 8' 1" HIGH

Depth	Starter Unit No.	Add On Unit No.
12"	OSB 97-1248-5	OAB 97-1248-5
15"	OSB 97-1548-5	OAB 97-1548-5
18"	OSB 97-1848-5	OAB 97-1848-5
24"	OSB 97-2448-5	OAB 97-2448-5
30"	OSB 97-3048-5	OAB 97-3048-5

6 SHELVES 36" WIDE x 8' 1" HIGH

Depth	Starter Unit No.	Add On Unit No.
12"	OSB 97-1236-6	OAB 97-1236-6
15"	OSB 97-1536-6	OAB 97-1536-6
18"	OSB 97-1836-6	OAB 97-1836-6
24"	OSB 97-2436-6	OAB 97-2436-6
30"	OSB 97-3036-6	OAB 97-3036-6

42" WIDE x 8' 1" HIGH

Depth	Starter Unit No.	Add On Unit No.
12"	OSB 97-1242-6	OAB 97-1242-6
15"	OSB 97-1542-6	OAB 97-1542-6
18"	OSB 97-1842-6	OAB 97-1842-6
24"	OSB 97-2442-6	OAB 97-2442-6
30"	OSB 97-3042-6	OAB 97-3042-6

48" WIDE x 8' 1" HIGH

Depth	Starter Unit No.	Add On Unit No.
12"	OSB 97-1248-6	OAB 97-1248-6
15"	OSB 97-1548-6	OAB 97-1548-6
18"	OSB 97-1848-6	OAB 97-1848-6
24"	OSB 97-2448-6	OAB 97-2448-6
30"	OSB 97-3048-6	OAB 97-3048-6

7 SHELVES 36" WIDE x 8' 1" HIGH

Depth	Starter Unit No.	Add On Unit No.
12"	OSB 97-1236-7	OAB 97-1236-7
15"	OSB 97-1536-7	OAB 97-1536-7
18"	OSB 97-1836-7	OAB 97-1836-7
24"	OSB 97-2436-7	OAB 97-2436-7
30"	OSB 97-3036-7	OAB 97-3036-7

42" WIDE x 8' 1" HIGH

Depth	Starter Unit No.	Add On Unit No.
12"	OSB 97-1242-7	OAB 97-1242-7
15"	OSB 97-1542-7	OAB 97-1542-7
18"	OSB 97-1842-7	OAB 97-1842-7
24"	OSB 97-2442-7	OAB 97-2442-7
30"	OSB 97-3042-7	OAB 97-3042-7

48" WIDE x 8' 1" HIGH

Depth	Starter Unit No.	Add On Unit No.
12"	OSB 97-1248-7	OAB 97-1248-7
15"	OSB 97-1548-7	OAB 97-1548-7
18"	OSB 97-1848-7	OAB 97-1848-7
24"	OSB 97-2448-7	OAB 97-2448-7
30"	OSB 97-3048-7	OAB 97-3048-7

8' 1" HIGH CLOSED TYPE • BOXER™ (BOX-SHELF): 22 GA., 20 GA. and 18 GA.

UNIT NUMBERS ON THIS PAGE ARE 20 GA. – ADD L FOR 22 GA., X FOR 18 GA.

5 SHELVES 36" WIDE x 8' 1" HIGH

Depth	Starter Unit No.	Add On Unit No.
12"	CSB 97-1236-5	CAB 97-1236-5
15"	CSB 97-1536-5	CAB 97-1536-5
18"	CSB 97-1836-5	CAB 97-1836-5
24"	CSB 97-2436-5	CAB 97-2436-5
30"	CSB 97-3036-5	CAB 97-3036-5

42" WIDE x 8' 1" HIGH

Depth	Starter Unit No.	Add On Unit No.
12"	CSB 97-1242-5	CAB 97-1242-5
15"	CSB 97-1542-5	CAB 97-1542-5
18"	CSB 97-1842-5	CAB 97-1842-5
24"	CSB 97-2442-5	CAB 97-2442-5
30"	CSB 97-3042-5	CAB 97-3042-5

48" WIDE x 8' 1" HIGH

Depth	Starter Unit No.	Add On Unit No.
12"	CSB 97-1248-5	CAB 97-1248-5
15"	CSB 97-1548-5	CAB 97-1548-5
18"	CSB 97-1848-5	CAB 97-1848-5
24"	CSB 97-2448-5	CAB 97-2448-5
30"	CSB 97-3048-5	CAB 97-3048-5

6 SHELVES 36" WIDE x 8' 1" HIGH

Depth	Starter Unit No.	Add On Unit No.
12"	CSB 97-1236-6	CAB 97-1236-6
15"	CSB 97-1536-6	CAB 97-1536-6
18"	CSB 97-1836-6	CAB 97-1836-6
24"	CSB 97-2436-6	CAB 97-2436-6
30"	CSB 97-3036-6	CAB 97-3036-6

42" WIDE x 8' 1" HIGH

Depth	Starter Unit No.	Add On Unit No.
12"	CSB 97-1242-6	CAB 97-1242-6
15"	CSB 97-1542-6	CAB 97-1542-6
18"	CSB 97-1842-6	CAB 97-1842-6
24"	CSB 97-2442-6	CAB 97-2442-6
30"	CSB 97-3042-6	CAB 97-3042-6

48" WIDE x 8' 1" HIGH

Depth	Starter Unit No.	Add On Unit No.
12"	CSB 97-1248-6	CAB 97-1248-6
15"	CSB 97-1548-6	CAB 97-1548-6
18"	CSB 97-1848-6	CAB 97-1848-6
24"	CSB 97-2448-6	CAB 97-2448-6
30"	CSB 97-3048-6	CAB 97-3048-6

7 SHELVES 36" WIDE x 8' 1" HIGH

Depth	Starter Unit No.	Add On Unit No.
12"	CSB 97-1236-7	CAB 97-1236-7
15"	CSB 97-1536-7	CAB 97-1536-7
18"	CSB 97-1836-7	CAB 97-1836-7
24"	CSB 97-2436-7	CAB 97-2436-7
30"	CSB 97-3036-7	CAB 97-3036-7

42" WIDE x 8' 1" HIGH

Depth	Starter Unit No.	Add On Unit No.
12"	CSB 97-1242-7	CAB 97-1242-7
15"	CSB 97-1542-7	CAB 97-1542-7
18"	CSB 97-1842-7	CAB 97-1842-7
24"	CSB 97-2442-7	CAB 97-2442-7
30"	CSB 97-3042-7	CAB 97-3042-7

48" WIDE x 8' 1" HIGH

Depth	Starter Unit No.	Add On Unit No.
12"	CSB 97-1248-7	CAB 97-1248-7
15"	CSB 97-1548-7	CAB 97-1548-7
18"	CSB 97-1848-7	CAB 97-1848-7
24"	CSB 97-2448-7	CAB 97-2448-7
30"	CSB 97-3048-7	CAB 97-3048-7